



PLUG & PLAY



OWNER'S MANUAL

FANTASY OWNER'S MANUAL

110/230V System

Owner's Record

Locating the Spa Serial Number:

The spa serial number label is located on control box cover inside the equipment compartment. Equipment compartment access panel is below the spas 4-button topside control panel. You will need the spa model and serial number to properly register your spa and activate coverage. Write your spa information in the space provided.

DATE PURCHASED:

PURCHASED FROM:

SPA MODEL:

SERIAL NUMBER:

Please read this Owner's Manual carefully, as it is designed to provide you with the information you will need to ensure the safe, secure use of your spa.

IMPORTANT: Watkins Manufacturing Corporation reserves the right to change specifications and/or design without notification and without any obligation.

SPA SPECIFICATIONS

<u>Model</u>	<u>Spa Seating</u>	<u>Length</u>	<u>Width</u>	<u>Height</u>	<u>Dry Weight</u>	<u>Electrical Specs 60Hz</u>
Splendor+™	6 person	6'6"	6'6"	34 ¼"	388 lbs.	110/230V, 11 (19)/26A
Drift™	4 person	5'2"	5'10"	31 ¾"	276 lbs.	110/230V, 11 (19)/26A
Embrace™	3 person	6'	6'	31"	302 lbs.	110/230V, 11 (19)/26A
Entice™	5 person	7'2"	6'5"	33	380lbs.	110/230V, 11 (19)/26A

CAUTION

DO NOT OPERATE SPA BEFORE READING THIS MANUAL

Failure to read this manual and follow its instructions may result in unsafe operation and or permanent damage to your portable spa.

Most cities, counties, states, and countries require permits for exterior construction and electrical circuits. In addition, some communities have codes requiring residential barriers such as fencing and/or self-closing gates on the property to prevent unsupervised access to a pool or spa by children. Be sure to check with your local agencies for specific requirements.

If you need additional information and/or assistance, please contact Customer Service at 888-961-7727 Ext. 8440 or at ahsservice@watkinsmfg.com.

TABLE OF CONTENTS

TITLE	PAGE
CONTENTS	
SAFETY INFORMATION	
IMPORTANT SAFETY INSTRUCTIONS	1
IMPORTANT SPA INSTRUCTIONS	4
INSTALLATION	
PLANNING A LOCATION FOR YOUR SPA	5
PLACING THE SPA	6
EQUIPMENT ACCESS	
EQUIPMENT ACCESS PANEL	7
ELECTRICAL REQUIREMENTS	
ELECTRICAL REQUIREMENT	8
CONFIGURING SYSTEM	9
ELECTRICAL WIRING DIAGRAM FOR 230V USE	10
CONTROL PANEL OPERATION	
TEMPERATURE ADJUSTMENT (80°F-104°F)	11
JETS OPERATION	11
MULTI COLOR LED LIGHT	11
FILTER CYCLES	11
OPERATION MODE	12
SMART WINTER MODE	12
DIAGNOSTIC LCD MESSAGE	13
COMPONENT OPERATION	
SPA COMPONENT OPERATION	14
FILL UP AND START-UP INSTRUCTIONS	
FILLING THE SPA WITH WATER	15
APPLYING POWER	15
ADDING START-UP CHEMICALS	
WATER CHEMISTRY GUIDELINES	16
SPA MAINTENANCE	
FILTER CARTRIDGE MAINTENANCE	17
SURFACE CARE	18
COVER CARE	18
CABINET CARE	18
SPA LED REPLACEMENT	18
DRAINING OR WINTERIZING	
DRAINING YOUR SPA	19
WINTERIZING YOUR SPA	19
TROUBLESHOOTING PROCEDURES	
NO COMPONENT OPERATION	20
PUMP DOES NOT OPERATE, BUT THE LIGHT DOES	20
POOR JET ACTION	20
WATER IS TOO HOT	20

IMPORTANT SAFETY INSTRUCTIONS

READ AND FOLLOW ALL INSTRUCTIONS

AVOIDING THE RISK TO CHILDREN

DANGER:

- **RISK OF CHILD DROWNING.** Extreme caution must be exercised to prevent unauthorized access by children. To avoid accidents, ensure that children cannot use a spa unless they are supervised at all times.

WARNING:

- To reduce the risk of injury, do not permit children to use this product unless they are closely supervised at all times.
- To reduce the risk of injury, lower water temperatures are recommended for young children. Children are especially sensitive to hot water.

DO:

- Make sure you always lock the child resistant locks after using the spa for your children's safety. Every spa is equipped with a locking cover that meets the ASTM F1346-91 Standard for Safety Covers.
- Test the water temperature with your hand before allowing your child to enter the spa to be sure that it's comfortable. Children are especially sensitive to hot water.
- Remind children that wet surfaces can be very slippery. Make sure that the children are careful when entering or exiting the spa.

DON'T:

- Allow children to climb onto the spa cover.
- Allow children to have unsupervised access to the spa.

AVOIDING THE RISK OF ELECTROCUTION

Risk of Electrocution

- Connect only to a grounded source.
- Do not bury the power cord. A buried power cord may result in death or serious personal injury due to electrocution if direct burial-type cable is not used, or if improper digging occurs.
- A ground terminal (pressure wire connector) is provided on the control box inside the unit to permit connection of a minimum No. 10 AWG solid copper bonding conductor between this point and any metal equipment, metal water pipe, metal enclosures of electrical equipment, or conduit within five feet (1.5 m) of the unit as needed to comply with local requirements.

WARNING:

- To reduce the risk of electrical shock, replace a damaged cord immediately. Failure to do so may result in death or serious personal injury due to electrocution.
- Your spa is provided with a Ground Fault Circuit Interrupter for user and equipment protection. To ensure proper operation of this important safety device, test according to the following instructions per electrical configuration.

SAFETY INFORMATION

110 VOLT, CORD-CONNECTED MODELS:

- The GFCI is located at the end of the power cord. Before each use, with the unit operating, push the TEST button. The unit should stop operating and the GFCI power indicator will go out. Wait 30 seconds and then reset the GFCI by pushing the RESET button. The GFCI power indicator will turn on, restoring power to the spa. If the interrupter does not perform in this manner, there may be an electrical malfunction and with it, the possibility of an electric shock. Disconnect the power until the problem has been corrected.

NOTE: This will reset the filter cycle.

230 VOLT, CONVERTED MODELS:

- A ground terminal is provided on the control box. To reduce the risk of electric shock, connect this terminal to the grounding terminal of your electrical service or subpanel with a continuous green, insulated copper wire. The wire must be equivalent in size to the circuit conductors supplying the equipment. In addition, a bonding terminal (pressure wire connector) is provided on the outside of the control box for bonding to local ground points. To reduce the risk of electric shock, this connector should be bonded with a No. 8 AWG (8.4 mm²) solid copper wire to any metal ladders, water pipes, or other metal within 5 feet (1.5 m) of the spa to comply with local requirements. The means of disconnection must be readily accessible, but must be installed at least 5 feet (1.5 m) from the spa.
- Your spa requires a suitably rated circuit breaker to open all ungrounded supply conductors.
- Your spa must have a ground fault circuit interrupter in an electrical subpanel. Before each use of the spa and with the unit operating, push the TEST button on the breaker. The switch should click over to the "Trip" position. Wait 30 seconds and reset the GFCI breaker by switching it completely off and then completely on. The switch should then stay on. If the interrupter does not perform in this manner, it is an indication of an electrical malfunction and the possibility of an electric shock. Disconnect the power until the fault has been identified and corrected.

IMPORTANT: Failure to wait 30 seconds before resetting the GFCI may cause the spa's Power Indicator (on the control panel) to blink. If this occurs, repeat the GFCI test procedure.

DANGER: RISK OF ELECTRICAL SHOCK

- Install spa at least 5 feet (1.5 m) from all metal surfaces. A spa may be installed within 5 feet of a metal surface if each metal surface is permanently connected by a minimum No. 10 AWG solid copper conductor attached to the wire ground connector on the terminal box that is provided for this purpose if in accordance with National Electrical Code ANSI/NMFA70-1993.
- Do not permit any electrical appliances, such as a light, telephone, radio, or television within 5 feet (1.5 m) of a spa. Failure to maintain a safe distance may result in death or serious personal injury due to electrocution if the appliance should fall into the spa.
- Install your spa in such a way that drainage is away from the electrical compartment and from all electrical components.

DO:

- Be sure your spa is connected to the power supply correctly - use a licensed electrical contractor.
- Disconnect the spa from the power supply before draining the spa or servicing the electrical components.
- Test the Ground Fault Circuit Interrupter(s) before each use.

SAFETY INFORMATION

DON'T:

- Use the spa with the equipment compartment door removed.
- Place electrical appliances within 5 feet (1.5m) of the spa.
- Use an extension cord to connect the spa to its power source. The cord may not be properly grounded and the connection is a shock hazard. An extension cord may cause a voltage drop, which will cause overheating of the jet pump motor and motor damage.
- Attempt to open the electrical control box. There are no user serviceable parts inside.

RISKS TO AVOID

⚠ DANGER: RISK OF INJURY

- DO NOT sit in the filter compartment area. Sitting in this area can cause:
a) Restriction of Filter Pump suction/vacuum b) Damage to components
- Both can result in bodily harm. Should damage occur to components in this area, replace immediately!

To reduce the risk of injury to persons, DO NOT remove floating weir, basket, and filter located in the filter compartment while the spa is running.

- The suction fittings in the spa are sized to match the specific water flow created by the pump. Never replace a suction fitting with one rated less than the flow rate marked on the original suction fitting.
- There is a danger of slipping and falling. Remember that wet surfaces can be very slippery. Take care when entering or exiting the spa.
- Never operate spa if the suction fittings are broken or missing.
- People with infectious diseases should not use the spa.
- Keep any loose articles of clothing or hanging jewelry away from rotating jets or other moving components.

Increased side effects of medication

- The use of drugs, alcohol or medication before or during spa use may lead to unconsciousness with the possibility of drowning.
- Persons using medications should consult a physician before using a spa; some medication may cause a user to become drowsy, while other medication may affect heart rate, blood pressure, and circulation.
- Persons taking medications which induce drowsiness, such as tranquilizers, antihistamines or anticoagulants should not use the spa.

Health problems affected by spa use

- Pregnant women should consult a physician before using spa.
- Persons suffering from obesity or with a medical history of heart disease, low or high blood pressure, circulatory system problems, or diabetes should consult a physician before using spa.

Unclean water

- Keep the water clean and sanitized with correct chemical care. The recommended levels for your spa are:
Free Available Chlorine (FAC): 3.0-5.0 ppm Total Alkalinity: 80 - 120 ppm
Water pH: 7.2 - 7.8 Calcium Hardness: 100- 250 ppm

IMPORTANT: Turn jet pump on for at least ten minutes after adding ANY spa water chemicals into the filter compartment.

- Clean the filter cartridge monthly to remove debris and mineral buildup which may affect the performance of the hydromassage jets, limit the flow, or trip the high-limit thermostat which will turn off the entire spa.

SAFETY INFORMATION

AVOIDING THE RISK OF HYPERTHERMIA

Prolonged immersion in hot water can result in HYPERTHERMIA, a dangerous condition which occurs when the internal temperature of the body reaches a level above normal (98.6°F, 37°C). The symptoms of hyperthermia include unawareness of impending hazard, failure to perceive heat, failure to recognize the need to exit the spa, physical inability to exit the spa, fetal damage in pregnant women, and unconsciousness resulting in a danger of drowning.

⚠ WARNING:

The use of alcohol, drugs, or medication can greatly increase the risk of fatal hyperthermia in hot tubs and spas.

TO REDUCE THE RISK OF INJURY:

- The water in the spa should never exceed 104°F (40°C). Water temperatures between 100°F (38°C) and 104°F (40°C) are considered safe for a healthy adult. Lower water temperatures are recommended for extended use (exceeding 10 minutes) and for young children. Extended use can cause hyperthermia.
- Pregnant or possibly pregnant women should limit spa water temperatures to 100°F (38°C). Failure to do so may result in permanent injury to your baby.
- Do not use spa immediately following strenuous exercise.

AVOIDING THE RISK OF SKIN BURNS:

- To reduce the risk of injury, before entering a spa the user should measure the water temperature with an accurate thermometer.
- Test the water with your hand before entering the spa to be sure it's comfortable.

SAFETY SIGN

A SAFETY SIGN in the owner's package. The sign, which is required as a condition of Product Listing, should be permanently installed where it is visible to the users of the spa.

IMPORTANT SPA INSTRUCTIONS

The following contains important spa information, and we strongly encourage you to read and apply them.

DO:

- Use and lock the vinyl cover when the spa is not in use, whether it is empty or full.
- Follow the Spa Care and Maintenance recommendations stated in this manual.
- Use only approved accessories and recommended spa chemicals and cleaners.

DON'T:

- Leave the spa exposed to the sun without water or the vinyl cover in place. Exposure to direct sunlight can cause solar distress of the shell material.
- Roll or slide the spa on its side. This will damage the siding.
- Lift or drag the cover by using the cover lock straps; always lift or carry the cover by using the handles.
- Attempt to open the electrical control box. There are no user serviceable parts inside. Opening of the control box by the spa owner will void the warranty. If you have an operational problem, carefully go through the steps outlined in the Troubleshooting section. If you are not able to resolve the problem, contact your authorized dealer. Many problems can easily be diagnosed over the telephone by an Authorized Service Technician.

PLANNING A LOCATION FOR YOUR SPA

Consider these things when determining where to place your spa.

SAFETY FIRST:

Make sure your spa is positioned so access to the equipment compartment and side panels will not be blocked. Be certain your installation will meet all city and local safety codes and requirements.

PLANNED USE OF SPA:

How you intend to use your spa will help you determine where you should position the spa. For example, will you use it more for recreational or therapeutic purposes? If your spa is mainly for family recreation, leave plenty of room around it for activity and lawn furniture. If you will use it more for relaxation and therapy, you'll probably want to create privacy around the spa.

PRIVACY:

Think of your surroundings during all seasons to determine your best privacy options. Consider the view of your neighbors when you plan the location of your spa.

VIEWS:

Think about the direction you will be facing when sitting in your spa. Do you have a special landscape you will find enjoyable? Perhaps there is an area that has a soothing breeze during the day or a lovely sunset in the evening.

ENVIRONMENT:

If you live in a climate with a snowy winter and hot summer, a place to change clothes or a house entry near the spa is convenient. A warmer climate may require shade from the hot sun. Consider placement of trees, shrubs, patio cover or perhaps a gazebo structure to provide what you will need. Indoor installations require adequate ventilation. When the spa is in use, considerable amounts of moisture are produced. This moisture can damage walls and ceiling surfaces over time. Special paint is available to resist moisture damage. Remember that spas periodically require drainage, so plan your environment accordingly.

KEEP CLEAN:

Prevent dirt and foliage from being tracked into your spa by utilizing concrete for paths and access areas. Check the location of spill paths from gutters, trees, and shrubs.

SERVICE ACCESS:

Many people choose to install tile or custom wood around their spas. If you are installing your tub with custom decorative trimming, remember to allow for access to it for service. Should you need service, a technician may need to remove the tub's door panel, or access it from beneath. It is always best to design special installations so the spa can still be moved, or lifted from the ground.

A GOOD FOUNDATION:

Your new spa needs a good solid foundation. The area your spa sits on must be able to support the spa, the water in it and those who use it. If the foundation is inadequate, it may shift or settle after the spa is in place, causing stress to the shell or components. **NOTE:** Do Not shim your spa in any manner, as this could cause the cabinet to warp, thereby voiding the warranty.

INSTALLATION

BE AWARE:

Damage caused by inadequate or improper foundation support is not covered by the spa warranty. It is the sole responsibility of the spa owner to provide a proper foundation for the spa.

Make sure the foundation where the spa is placed drains water away from the spa. Proper drainage will keep components dry from rain and wet weather.

Your spa weight must always be considered when installing your spa. If you are installing it on an elevated wood deck or other structure, it is advisable to consult a structural engineer or contractor to ensure the structure will support the weight.

IT IS STRONGLY RECOMMENDED THAT A QUALIFIED, LICENSED CONTRACTOR PREPARE THE FOUNDATION FOR YOUR SPA.

A reinforced concrete pad at least four inches thick is recommended for your spa. The reinforcing rod or mesh in the pad should be attached to a bond wire.

INDOOR INSTALLATION:

Be aware of some special requirements if you place your spa indoors. Water will accumulate around the spa, so flooring materials must provide a good grip when wet. Proper drainage is essential to prevent a build-up of water around the spa. When building a new room for the spa, it is recommended that a floor drain be installed. The humidity will naturally increase with the spa installed. Water may get into woodwork and produce dryrot, mildew, or other problems. Check for airborne moisture's effects on exposed wood, paper, etc. in the room. To minimize these effects, it is best to provide plenty of ventilation to the spa area. An architect can help to determine if more ventilation must be installed.

PLACING THE SPA

CHECK THE DIMENSIONS OF YOUR SPA:

Compare the spa dimensions to the width of gates, sidewalks, and doorways along the delivery route used to bring the spa into your yard. It may be necessary for you to remove a gate or partially remove a fence in order to provide an unobstructed passageway to the installation location. Also, keep in mind—if you are using special equipment to place your spa into an area it will be necessary to include those measurements and weights.

PLANNING A DELIVERY ROUTE:

Check the width of gates, doors and sidewalks to make sure your spa will pass through unobstructed. You may have to remove a gate or part of a fence to allow for adequate width clearance. If the delivery route will require a 90-degree turn, check the measurements at the turn to ensure the spa will fit. Check for protruding gas meters, water meters, A/C units, etc., on your home which will cause obstructions along the delivery path to your yard. Check for low roof eaves, over hanging branches or rain gutters that could be an obstruction to overhead clearances.

SPECIAL CIRCUMSTANCES:

The use of a crane for delivery and installation is primarily to avoid injury to your spa, your property or to delivery personnel. Our Customer Service may be able to assist you with the arrangements. Cranes are not considered "normal delivery".

EQUIPMENT ACCESS

EQUIPMENT ACCESS PANEL

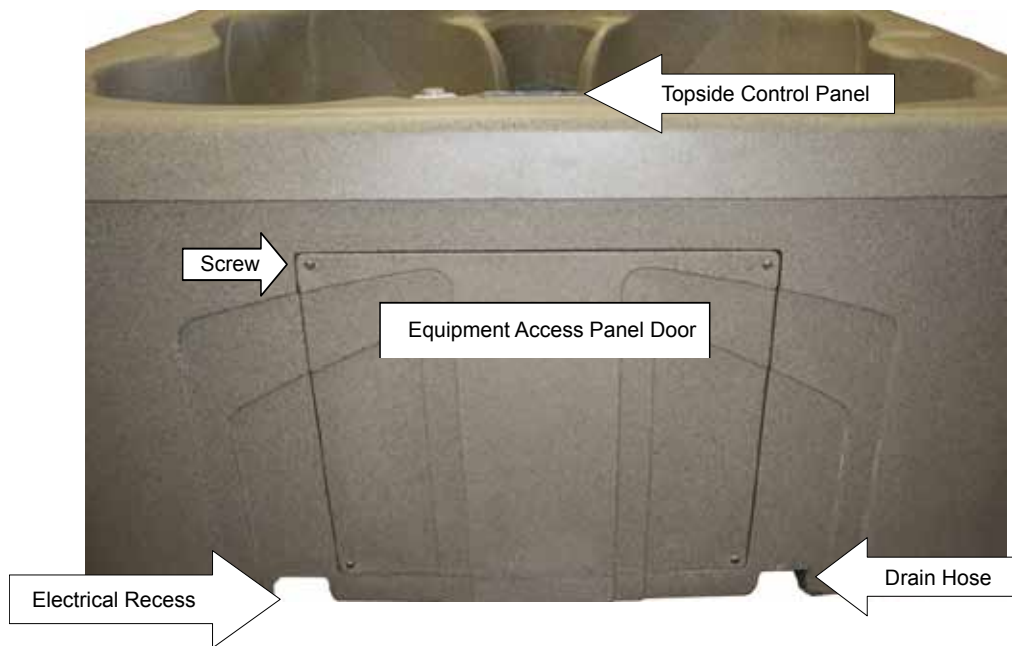

To access the equipment compartment:

- Remove 4 screws from Equipment Access Panel Door then remove door.

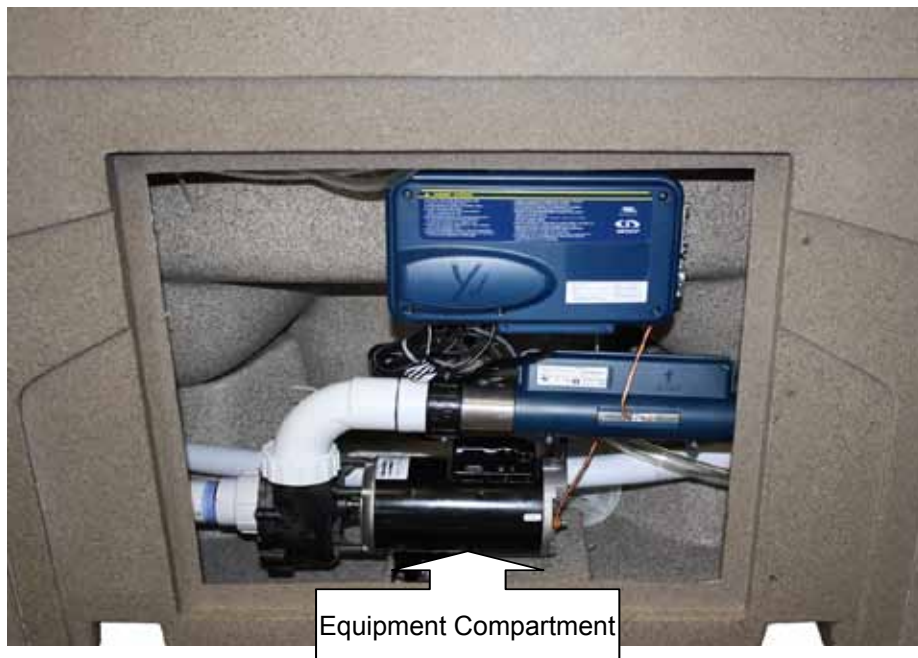

ELECTRICAL REQUIREMENTS

ELECTRICAL REQUIREMENT

⚠ DO NOT POWER THE SPA WITHOUT FIRST FILLING WITH WATER!

⚠ DANGER – RISK OF ELECTRIC SHOCK

Installations that do not conform to the following procedures and requirements may expose users to electric shock. Non-conforming installations will not be covered under warranty.

If installed in the United States, the electrical wiring of this spa must meet the requirements of the National Electric Code (NEC) and any applicable state or local codes. The electrical circuit must be installed by an electrical contractor and approved by a local building electrical inspection authority.

1. Installations within 5 feet of any metal surfaces must ground the metal surfaces to the hot tub. Use an 8 AWG solid copper wire and attach it to the grounding lug on the control, located in the equipment compartment.
2. Only a licensed electrician may install power to the spa.
3. Power supply installation must include a suitably rated ground fault circuit interrupter (GFCI) as required by NEC Article 680-42. The circuit breaker must be dedicated and should not be shared with any other appliances. It must be labeled and easily accessible to users.
4. The electrical supply for the spa must include a suitable rated switch or circuit breaker to open all ungrounded supply conductors to comply with Section 422-20 of the National Electric Code, ANSI/NFPA 70. The disconnecting means must be readily accessible to the spa's occupant but installed at least 5 feet from the spa water.
5. 230V Power supply lines must be hard wired into the control box. DO NOT use extension or plug-type cords of any kind. The use of a shut-off box near the hot tub is also recommended. This box provides a quick and convenient method to shut off power to the hot tub for emergencies and maintenance.
6. Supply lines must be properly sized as per the NEC. A ground line must be provided that is as large as the largest current carrying conductor, but no less than 8 AWG. Use copper wiring only.
7. Please open the front cover of the control box, and follow the instructions and wiring diagram printed on the backside.
8. All 110 V powered models must use the provided 15 foot GFCI cord and be plugged directly into a dedicated grounded wall outlet.
9. CAUTION, 230V POWERED SPAS – These spas must be hard wired to your household electrical service box only. Do not use an extension cord or any other disconnect-able power cord. The use of an extension cord or a disconnect-able power cord is highly dangerous and will void all warranties!
 - Wire size must be appropriate per NEC and/or local codes.
 - Wire size is determined by length of run from breaker box to spa and maximum current draw.
 - THHN copper core wire is recommended.
 - All wiring must be copper to ensure adequate connections. Do not use aluminum wire.



Equipment access is below the topside control panel.

ELECTRICAL REQUIREMENTS

CONFIGURING SYSTEM

SELECTING THE VOLTAGE FOR YOUR SPA

Your spa is designed to operate at either 110V 15 amp; 110V 30 amp, or 230V 40 amp circuit.

- When the spa is setup for 110V, the heater will provide approximately 1000 watts of heat only when the pump is operating in LOW speed and the thermostat is calling for heat (NOTE: The heater does not operate when the pump is on high speed).
- When the spa is connected to 110V 30 amp, the heater will provide approximately 1000 watts of heat when the pump is operating in LOW or HIGH speed and the thermostat is calling for heat.
- When the spa is connected to 230 volts, the heater will provide approximately 4000 watts of heat when the pump is operating in LOW or HIGH speed and the thermostat is calling for heat.

All electrical connections must be made in accordance with the wiring information contained on the electrical control box cover and the National Electrical Code.

110 VOLT INSTALLATION (CORD CONNECTED)

Spas come with a factory-installed power supply GFCI cord and are to be plugged into a grounded type 110 volt, 15 ampere receptacle. No other electrical appliance or fixture can be used on this circuit.

IMPORTANT: Under **NO** circumstances should an extension cord be used. Use of an extension cord will seriously degrade the performance of the equipment and can create an electrical hazard.

110 VOLT 30A OR 230 VOLT 40A (PERMANENTLY CONNECTED FIELD CONVERSION)

- A 110 volt, 30 ampere configuration requires a 30 ampere GFCI Subpanel box (not included).
- A 230 volt, 40 ampere configuration requires a 40 ampere GFCI Subpanel (not included)

Either one of these installation requires a licensed electrician.

Field Converted 110V 30A Control Box

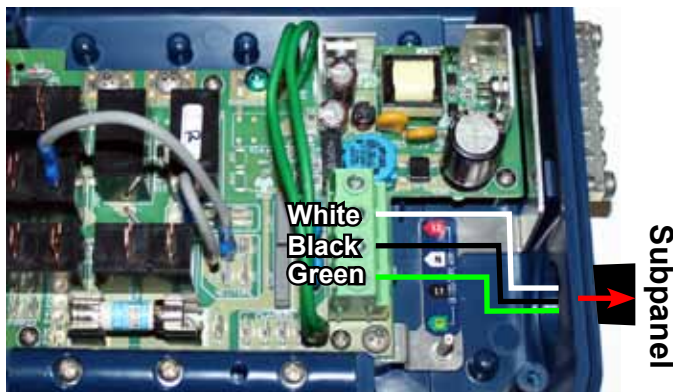

To Convert, remove the cord from the terminal block and replace with White, Black and Green #10 wires and connect to 30A GFCI Subpanel.

Field Converted 110/230V Control Box

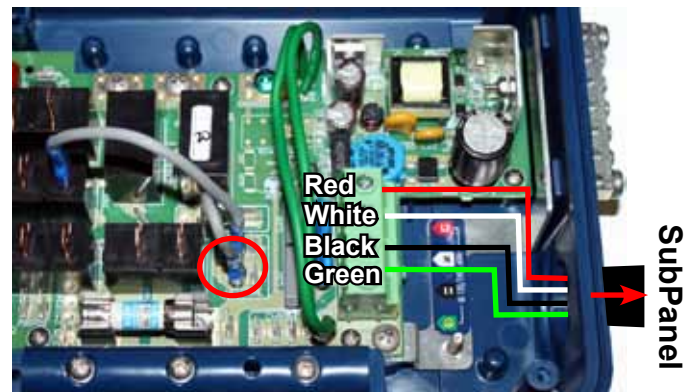

To Convert, move 230V jumper from P14 to P20 (see above). Remove the cord from the terminal block and replace with Red, White, Black and Green #8 wires and connect to 40A Subpanel.

IMPORTANT: After powering up the spa on 110V 30A or 230V 40A field conversions, a **program configuration is required**. Press and Hold JETS button for 30 seconds to access the Low Level (LL) settings on the control panel. Use the +/- button to change the setting from LL1 Factory Default (non concurrent heat and high speed) to LL2 (concurrent Heater and High Speed pump) configuration. Press the LIGHT button within 25 seconds to save the new program setting.

ELECTRICAL REQUIREMENTS

ELECTRICAL WIRING DIAGRAM FOR 230V USE

It is recommended that a licensed electrician install the power to your spa in accordance with the National Electric Code and/or any local electrical codes in effect at the time of installation.

Power supply installation must include a properly rated GFCI circuit breaker. The circuit must be dedicated and should not be shared with any other appliances. The power supply must be hard wired into the power pack.

230V Wiring Instructions:

4 wires/Minimum 40 amp GFCI
Breaker #8 AWG 75°C Copper Wire
Minimum (less than 100' length)

Special Note:

If the GFCI breaker trips immediately after attempting to turn on, please check the White Neutral Wire that is connected to the spa.

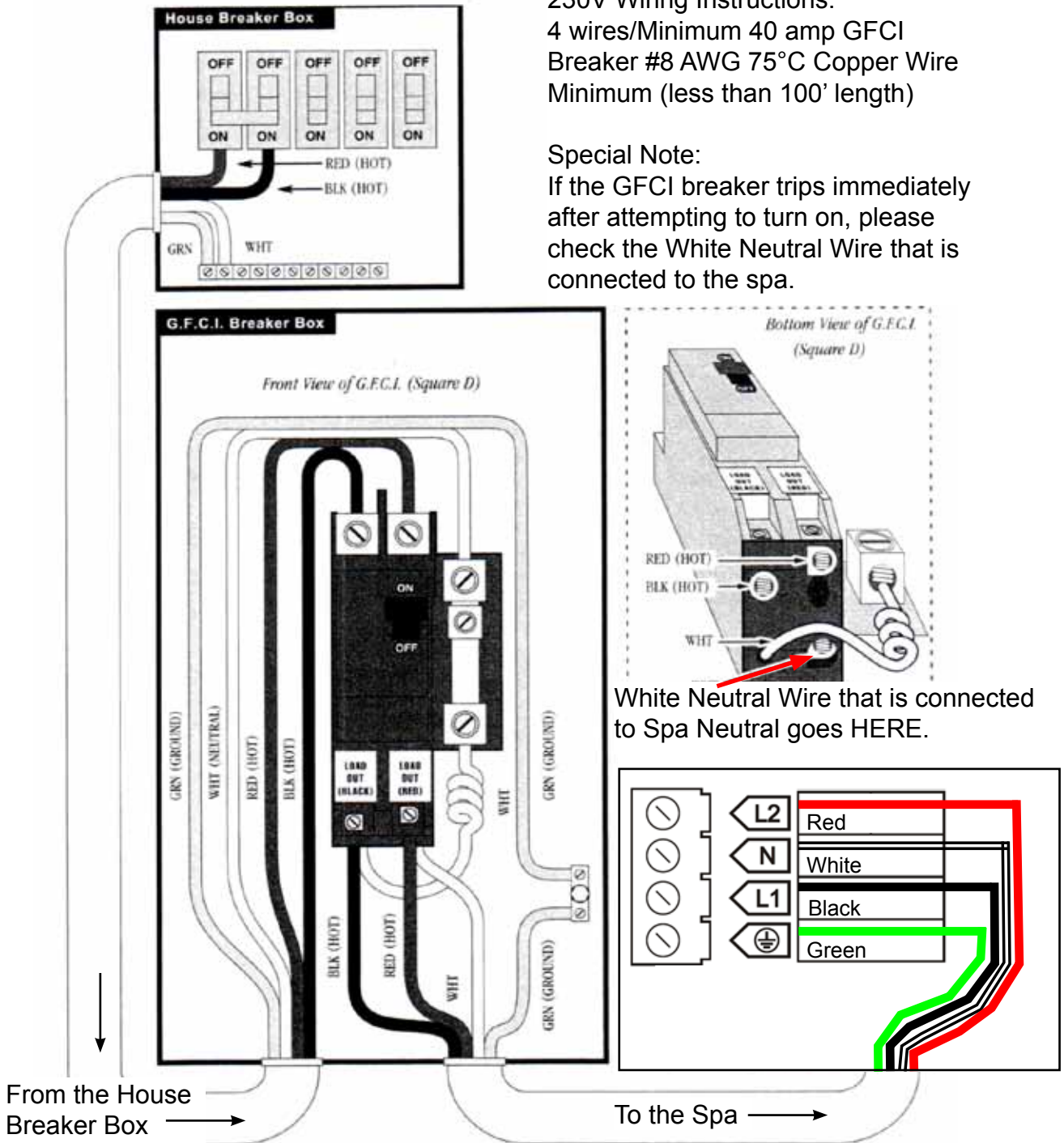

CONTROL PANEL OPERATION

INITIAL START-UP - When the spa is first powered up the control system begins a 2 minute Startup Mode. Different codes will display on the screen. Once Startup Mode completes, the actual temperature is displayed on the screen, and the spa will then begin to heat and maintain the water temperature and the first filter cycle will start. Your spa has been designed so that it will automatically heat the water to the factory set temperature of 100°F unless you set the spa to a different temperature. If power is disconnected from the spa, it will automatically revert back to the last saved set temperature when power is reapplied.

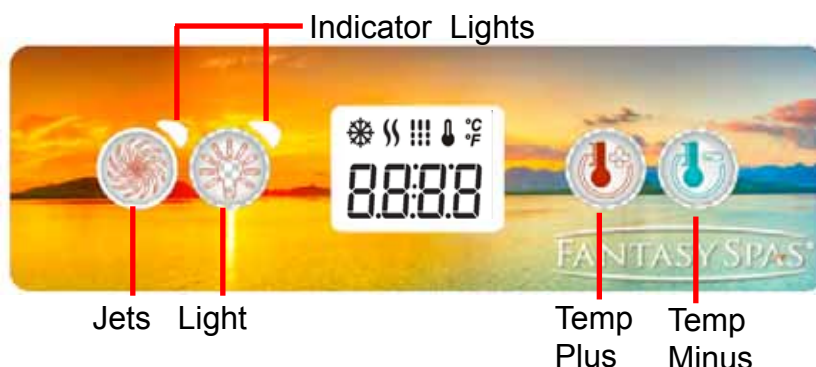

TEMPERATURE

ADJUSTMENT (80°F-104°F/26°C-40°C) ⏸

The temperature can only function between 80°F - 104°F / 26°C - 40°C. The last measured temperature will constantly display on LCD.

Press the *Plus* or *Minus* buttons to display the set temperature and indicator 🌡. Each time either button is pressed again, the set temperature will increase or decrease depending on which button is pressed. After five seconds, the LCD will automatically display the current spa temperature.

The “heater” indicator ⏸ lights up when the heater is on. It flashes when there is a request for more heat, but the heater is not on. Once set temperature is reached the indicator ⏸ shuts off and the low speed of the jet pump turns off after 30 seconds (if not in filter cycle).

JETS OPERATION

Firmly press the *Jets* button once to activate the low speed of the pump and again for the high speed. Firmly press the *Jets* button again to turn off the pump. If left running the low or high speed pump will automatically turn off after 1 hour. The “Jets” indicator light next to the button will blink when jet pump is on low speed and is solid on high speed.

MULTI COLOR LED LIGHT

Press the *Light* button once to turn on the light, the light indicator next to the button is lit when the light is on. Press the button again to turn the light off. Every time the light is quickly turned off and on a new light mode will appear. The sequence is as follows: White, Slow Full color wheel, Amber, Blue, Red, Green, Purple, Blue/Green color wheel, Red/Green color wheel and Fast Full color wheel. The last light mode used will come back on when the light is turned off for more than 2 seconds.

NOTE: If left on, the light will automatically turn off after 4 hours of operation.

FILTER CYCLES 🌀

There are two filter cycles: the first cycle (F1) starts right after power up and the second cycle (F2) will start 12 hours later. The default duration for the first filter cycle is 1 hour, and 30 minutes for the second cycle. Filter cycles only run at low speed. The “Filter” indicator 🌀 lights up when a filter cycle is on. The duration of each filter cycle can be modified.

CONTROL PANEL OPERATION

ADJUSTING PRESET FILTER CYCLES

Filter duration is programmable between 0 and 6 hours in 30 minute increments (0.5 hours) for both filter cycles. To program the cycle times:

1. Press and hold *Light* button for 5 seconds until F1 is displayed.
2. Press the *Plus* or *Minus* button to adjust the cycle time for F1.
3. Press the *Light* button to store the F1 cycle and move to the F2 cycle.
4. Press the *Plus* or *Minus* button to adjust the cycle time for F2.
5. Wait 15 seconds to allow the exit timer to expire and store the setting.

IMPORTANT: To reset the first filter cycle start time, skip step 5 and continue pressing the *Light* button until the actual temperature is displayed. Powering down of the spa will also reset the first filter start time.

FILTER CYCLE SUSPENSION: The filter cycle will be suspended every time a jet pump or light is activated manually during the filter cycle time. The suspension will end 10 minutes after the completion of the manual use.

OPERATIONAL MODES

The Standard Mode is the default operational mode preset from the factory. In order to program the spa to operate in the Economy mode you must enter the programming mode to make the change.

STANDARD MODE: Is programmed to maintain the desired temperature.

ECONOMY MODE: The spa will heat normally during the filter cycle; outside of the filter cycle, the set point will be lowered by 20°F. To enter the programming screen and toggle between Standard and Economy Mode the following is required:

1. Press and hold the *Light* button for 5 seconds
2. Press the *Light* button several times until EP 0 or EP 1 is displayed.
3. Use the *Plus* or *Minus* button to choose between Standard and Economy Mode.
EP 0 = Standard Mode and EP 1 = Economy Mode.
4. Wait 15 seconds to allow the exit timer to expire and store the setting.

OFF MODE: This mode allows you to stop all spa functions for 30 minutes to perform quick spa maintenance. To place the spa in OFF MODE, press and hold the Jets button for 5 seconds. The display will toggle between OFF and water temperature when in the OFF MODE. To stop the OFF MODE before the 30 minute cycle time is complete, simply tap (short press) the Jet button.

FAHRENHEIT/CELSIUS SETTING

To Change water temperature display to either Fahrenheit or Celsius, press and hold *Light* button for 5 seconds until F1... is displayed. Press the *Light* button several times until F or C  is displayed. Press the *Plus* or *Minus* button to change. Wait 15 seconds to allow the exit timer to expire and store the setting.

SMART WINTER MODE

The Smart Winter Mode is used to prevent water from freezing in the plumbing of the spa. As soon as there is a risk of freezing, this protection kicks in. The SWM protection will turn back off only after 24 hours without a risk of freezing. During this 24 hour period, the Smart Winter Mode icon remains on; the icon blinks when the purge is active.

CONTROL PANEL OPERATION

DIAGNOSTIC LCD MESSAGE

Message	Meaning	Action Required
	No message on display. Power has been cut off to the spa.	The control panel will be disabled until power returns. Spa settings will be preserved until next power up.
HL	The system has shut the heater off because the temperature at the heater has reached 122°F (50°C). Do not enter the water!	DO NOT ENTER THE WATER. Remove the spa cover and allow the water to cool down, then shut power off and power your spa up again to reset the system. If spa does not reset, shut off the power to the spa and call Customer Service.
AOH	Temperature inside the equipment compartment is too high 194F (90°C), causing the internal temperature in the control system to increase above normal limits.	Open equipment compartment and wait until error clears.
PRR	A problem is detected with the temperature probe.	Call your dealer or service supplier.
OH	The water temperature in the spa has reached 108°F (42°C). Do not enter the water!	Remove the spa cover and allow the water to cool down to a lower temperature. Call your dealer or service supplier if problem persists.
UPL	No low level configuration software has been installed into the system.	Call your dealer or service supplier.
FLO	No water flow is detected by the control system but flow is expected.	Make sure that the jet pump is running and water is flowing; check and clean filters; make sure water valves are open; make sure spa has a proper water level. If problem persists, call your dealer or service supplier.

Warning! Shock Hazard! No User Serviceable Parts.

Do not attempt service of the control box. Contact Customer Service for assistance. Follow all owner manual power connection instructions. Installation must be performed by a licensed electrician and all grounding connections must be properly installed.

WARNING! DO NOT ENTER SPA IF WATER IS TOO HOT

Water is too hot. Overheat protection heater is deactivated. Spa water temperature is above acceptable limits. When the actual water temperature is approximately 2° F (1° C) above the set temperature, the jet pump will stop operating to reduce (frictional) heating. If the spa water temperature continues to rise and gets above 108° F (42°C), the spa will go into an “OH” overheat condition.

SPA COMPONENT OPERATION

AIR CONTROL VALVE

The air control valve serves to regulate the amount of air mixed with the water when the jets are operational. Rotate all the air control valves counterclockwise and observe the increased jet action. Rotating the air control in the opposite direction to turn air off and allow the jets to work with water only. Turn the air controls off when the spa is not in use, this will prevent cold air from entering the spa and will keep heating cost to a minimum. The ozone jet, will always produce air bubbles when pump is on.

HYDROTHERAPY JETS

The hydrotherapy jets are recessed in the wall of the spa. Rotate the medium jet faces counterclockwise to turn the jets on, clockwise to turn the jets off. Turning a jet on or off will increase or decrease the effects of any jets not in the closed position.

OZONE GENERATOR (OPTIONAL)

The ozone system enhances the quality of the spa water when used to supplement the spa owner's regular water maintenance program. Contrary to some information circulated throughout the pool and spa industry regarding ozone systems, ozone **CAN'T** be used as a single-source sanitizer, water clarifier, anti-foamer, and mineral chelating agent. A secondary source sanitizer must be used to maintain 3.0 - 5.0 ppm of Free Available Chlorine (FAC). Watkins Manufacturing Corporation recommends that a chemical maintenance program based on recognized and documented industry standards still be followed when using an ozone purification system to assure water sanitation and the highest quality purified water.

WATERFALL

Your spa has a control valve to operate the amount of flow through the waterfall from no flow to a steady stream. This valve is located next to the waterfall. **Note:** The air control valve and the waterfall flow valve may look and function exactly the same and may operate in the same way, however; they will be separate components.

FILL UP AND START-UP INSTRUCTIONS

The following procedures should be followed on initial startup and whenever the spa is drained for routine maintenance.

FILLING THE SPA WITH WATER

1. Clear all the debris from your spa.
2. Be sure to open all jets to allow as much air as possible to escape from the plumbing during the filling process.
3. Insert a garden hose into filter compartment to fill your spa.

NOTE: Do not use hot or softened water.

4. As the water level rises, check inside the equipment compartment for water leaks. It may be necessary to tighten unions and/or fittings that may have loosened during delivery. There is no need to call for service; this can easily be done. If assistance is required, contact a Customer Service representative at (888) 961-7727 Ext. 8440

5. Under normal circumstances keep the water level half way between the top of the spa and the top of the gray filter ring or just above the highest jets (whichever is higher).

Failure to keep enough water in your spa may result in damage to your system and invalidate your warranty. If your spa filter is sucking in air causing the pump to cavitate, you need to add water!

6. Check the filter installation and make sure the filter is not loose.



UNIONS

APPLYING POWER

1. Turn power to spa "ON" from the main panel at the house and the subpanel.
2. Press the *Jets* button on the topside control panel to activate the spa. Rotate all the air control valves counterclockwise and observe the increased jet action (air mixed with water).
3. While the pump is running check again for water leaks at the drain spigot, unions, or fittings in the equipment compartment (leaks may have occurred during transit). If water is leaking from one of these areas, there is no need to call for service. Simply tighten the fitting. If assistance is required, call a Customer Service representative at (888) 961-7727 Ext. 8440.
4. After checking your spa for leaks it is now time to adjust your spa settings. Press the *Up* or *Down* button on your topside control panel until the display indicates your desired temperature is set.

ADDING START-UP CHEMICALS

WATER CHEMISTRY GUIDELINES

The following step-by-step instructions are a recommended guideline for balancing water chemistry. If unsure about any step in the process, please contact a Customer Care Associate at (888) 961-7727 Ext. 8440 or by email at ahsservice@watkinsmfg.com.

Initially, it is advisable to identify what minerals (e.g. iron) are present in the local source water. This will provide a better understanding of how to treat the water. Please follow the four steps below and be sure to achieve the correct levels in each area before moving onto the next step.

STEP #1: ESTABLISH PROPER PH LEVEL:

The recommended range for pH is between 7.2 and 7.8. If the reading is too high, lower the pH by using a pH Down/Decreaser (sodium bisulfate). If the pH level needs to be increased, do so with a pH Up/Increaser (sodium hydrogen carbonate). Any pH Up or Down should be added one teaspoon at a time, waiting one-half hour between application and re-measuring.

STEP #2: MEASURE TOTAL ALKALINITY:

The ideal range is between 80-120 parts per million (PPM). If the total alkalinity is too high, it should be reduced by using an Alkalinity Down/Decreaser (sodium bisulfate). If the total alkalinity is too low, it can be increased by adding an Alkalinity UP/Increaser (sodium bicarbonate or sodium hydrogen carbonate). These products should be added in small amounts – a teaspoon at a time. After adding one teaspoon, wait one half hour before re-measuring. Once the safe range of total alkalinity is established, proceed to the next step.

STEP #3: DETERMINE CALCIUM HARDNESS:

It is important to bring the calcium reading to between 100-250 PPM. If the reading requires adjustment, it should now be corrected. If the water is too soft (a low reading) calcium hardness should be added to the water to increase the PPM reading. If the water is too hard (a high reading), it can be corrected by either: (A) a mixture of hard and soft water added to attain a reading in the safe range, or (B) addition of stain and scale control. If calcium hardness is a problem with the local source water (either too hard or too soft) a test kit, which measures calcium hardness, is essential.

STEP #4: SANITIZING:

After steps 1-3 are complete, **the spa must be sanitized using Chlorine (sodium dichlor)**. Add 2 teaspoons of Chlorine, and increase as necessary to reach a level of 3-5 ppm. Check and maintain this level weekly, and before and after using the spa. **IMPORTANT NOTE: A granulated sodium dichlor is highly recommended for sanitizing spa water. Never use a sodium trichlor tablet in any form even with a floater. As with any other chemicals, the sanitizer should be introduced to the spa with the jets running a minimum of 10 minutes.**

WEEKLY SHOCK:

Using a potassium monopersulfate (MPS) shock, add approximately 2 oz. spreading it over the water while the jets are running. Shocking is achieved by adding the MPS to turbulent water. Leave the cover up until the jets automatically turn off. The spas are equipped with an automatic time out feature that will shut the jets off after 15 minutes. Then return the cover to the closed position to maintain heat.

SPA MAINTENANCE

FILTER CARTRIDGE MAINTENANCE

Every two weeks, the filter cartridge should be cleaned to remove the objects and particles that have lodged in the cartridge pleats. Using household water pressure and a garden hose with a pressurized nozzle, push water from inside to outside of the pleats, forcing all the trapped particles out. **NOTE:** Never run your spa without a filter cartridge!!! This will invalidate your warranty.

NOTE: Filter cartridges should be replaced every six to eight months or earlier when needed. Dirty filters can cause your spa pump to burn out and will invalidate your warranty.

FILTER CARTRIDGE REMOVAL AND CLEANING INSTRUCTIONS

Spa uses a screw in filter cartridge that is easily removed.

- Turn off the power to the spa, (by turning OFF the subpanel breaker).
- Push down slightly and turn filter basket counter clockwise to unlock, then pull the basket and weir out.
- Unscrew the filter cartridge counter clockwise and bring it out of the spa (requires many turns).
- Rinse cartridge using a garden hose. Rotate and separate filter pleats while spraying water to remove all dirt and debris possible. Let filter dry and look for calcium deposits (scaling) or an oil film. If you find these, you will need to deep clean your filter cartridge with a “spa filter cleaner” solution to break down and remove unwanted deposits and oils. (For longer filter life you should soak filter in solution regularly.)

CAUTION! Always use proper eye protection when using chemicals, or high-pressure water. Read instructions on cleaning products and follow applicable safety and warning instructions listed on label.

CAUTION! Never scrub the filter cartridge with a brush, as this will cause the filter to wear out and come apart. Never let the spa pump run without a filter cartridge in the skimmer compartment. Running the spa without a filter cartridge may permit debris to enter the spa plumbing and void the warranty!



- Replace filter cartridge, then reinstall basket and weir, (insert and rotate clockwise to lock into position). **DO NOT OVERTIGHTEN!**
- Turn spa's power back on.

SPA MAINTENANCE

SURFACE CARE

Do not use solvents or abrasive cleaners to clean the spa. Typically, a mild detergent and water will resolve cleaning issues.

COVER CARE

Please keep your cover free from dirt at all times. Use a cover cleaner or a warm mild soapy water to clean the surface. Do not use any silicone-based products, as it will dry and may eventually crack the vinyl. **NOTE:** Do not stand on the cover at any time. Remove the cover when adding chemicals to your spa. This will extend the life of your cover. The gasses from burned off chemicals will be trapped under the cover, if not removed. These gasses may erode the protective lining of the foam inserts. This will not be covered under warranty.

CABINET CARE

Little maintenance is required to keep your spa cabinet looking good.

Spa cabinet product should be cleaned as needed to remove dirt and debris.

- NO abrasive or harsh chemicals should be used on the spa's cabinet.
- NO solvents or cleaners containing aromatic solvents should be used on the spas cabinet.
- Hot soapy water is the best choice for cleaning the spa's cabinet.

AVOID PROLONGED EXPOSURE TO DIRECT SUNLIGHT OR EXCESSIVE TEMPERATURES (100 °F or 38 °C) TO AVOID YOUR SPA CABINET FROM BUCKLING.

SPA LED REPLACEMENT

- Turn OFF the power to the spa.
- Remove the equipment compartment access door.
- Locate the rear of the spa light.
- To remove the LED board, turn outside housing counter clockwise ¼ turn, and pull out and remove LED board from socket.
- Replace by reversing the above steps.



DRAINING OR WINTERIZING

Every three to six months, depending upon the water condition, you need to renew your water.

CAUTION: READ THIS BEFORE DRAINING YOUR SPA

- To prevent damage to the spa's components, **UNPLUG OR TURN OFF SUBPANEL BREAKER BEFORE DRAINING. Do not power back up until your spa has been refilled with water.**
- There are certain precautions to keep in mind when draining your spa. If it is extremely cold, and the spa is outdoors, freezing could occur in the plumbing or the equipment.
- Do not leave the spa's shell (inside surface) exposed to direct sunlight.

DRAINING YOUR SPA

- If draining for the first time. Pull the hose bib out a few inches from the spa (located in the recess under the spa, just right and below the equipment access door)
- Unscrew and remove the drain cap.
- Attach hose bib to a garden hose and direct to an appropriate draining area, keeping the hose below the water line.
- After your spa is empty, clean the shell and filter cartridge. See "Spa Maintenance" section.
- After cleaning, remove garden hose, replace drain cap and push the hose bib back into the recess.
- Follow the "Fill up and Start-up Instructions" on page 15.



WINTERIZING YOUR SPA

If you plan to store your spa for the winter, you must also use a wet-vac to clean out the water lines to ensure they are free of any water. Water left in the lines might freeze and damage the lines and jets.

1. It will be necessary to remove all water from the interior plumbing.
2. Remove the floating weir, basket, and filter cartridge. Clean the filter cartridge and store in a dry place. Attach the vacuum hose to the **vacuum side** of the shop vac and thoroughly dry the filter compartment.
3. Using the shop vac, remove the water starting with the jets at the top and moving to the ones at the bottom of the spa. **NOTE:** When removing the water from jet openings, you may notice suction coming from another jet. With the help of a second person, block off any suction from the other jet using a large rag or cloth. This will help pull out the water that is trapped deep inside the main line.
4. Thoroughly dry the spa shell with a clean towel.
5. Using a funnel, pour Propylene glycol anti-freeze into the filter suction fittings and jet outlets. **CAUTION: Use only Propylene glycol as your anti-freeze. This is non-toxic. NEVER use automobile anti-freeze since it is toxic.**
6. Remove the pump drain plug located on the front of the pump housings. Allow all water to drain out. Place the drain plug in a reclosable plastic storage bag and store near the pump. Replace the drain plugs on start-up.
7. Unscrew the suction/discharge pump and heater unions and allow the water to drain. Leave union loose. **NOTE:** Tighten unions before filling spa.
8. Replace the equipment compartment door and secure with screws.

Note: Damage caused by improper winterizing will not be covered under warranty. You may want to contact Customer Service for proper winterizing.

TROUBLESHOOTING PROCEDURES

In the event the spa is not working the way it should, please first review all the installation and operating instructions in this manual and check the message on the panel display. If you are still not satisfied it is working properly, please follow the appropriate troubleshooting instructions.

CAUTION! WARNING! SHOCK HAZARD! No User Serviceable Parts.

Do not attempt service of the control box. Contact Customer Service for assistance. Follow all owner's manual power connection instructions.

NO COMPONENT OPERATION

Check the following:

1. Is there power to the spa?
2. Is the household circuit breaker tripped?
3. Is the subpanel (230V) or cord GFCI (110V) tripped?
4. If 1, 2 or 3 are yes contact Customer Service for assistance.

PUMP DOES NOT OPERATE, BUT THE LIGHT DOES

Press the *Jets* button:

The pump operates but no water flows to jets. Pump may not be properly primed. This can happen after the spa is drained and refilled. Press the *Jets* button several times, never leaving the motor on for more than 5-10 seconds at-a-time with no water coming of of jets.

POOR JET ACTION

1. Press the *Jets* button to make certain the pump is on.
2. Rotate all the air control valves counterclockwise and observe the increased jet action.
3. Make sure the water level is half way between top of spa and top of the gray filter ring.
4. Check for dirty filter. Clean, if necessary.
5. Make sure all jets are in the open position (turn counterclockwise).

WATER IS TOO HOT

1. Check desired temperature on topside control.
2. Check for a Diagnostic Message (in Control Panel Operation section).

OH - Overheat (spa is deactivated) DO NOT ENTER THE WATER.

If the spa has overheated you should remove the cover to promote heat reduction. The spa control system should reset itself when the water temperature reduces below 106°F or 41°C. When the spa falls below the reset temperature you can push any button on the topside control to reset the control system. If the spa will not reset, then shut off power to the spa and call Customer Service at (888) 961-7727 Ext. 8440.

Under extreme and/or prolonged weather conditions it is possible for the ambient temperature to exceed 106F/41C; effecting the water temperature of the spa and causing it to overheat. These conditions could cause the spa sensors to produce an OH message and prevent the usage of your spa during these conditions. The location of your spa should be reconsidered to reduce the outside temperature around the spa. For example, you may need to prevent direct sunlight on any surface of your spa. Regardless, do not enter your spa if the temperature is above 104°F.

Should checking the above steps fail to correct the problem, please contact Customer Service at (888) 961-7727 Ext. 8440.

